

63431 DR 132 =

Symbolische Darstellung
Symbolic Illustration
Illustration figurative

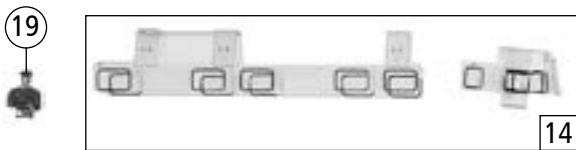
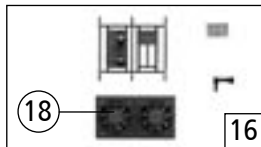

5
6

20 o. Abb. / no ill.
Lichtabdeckungsfolie
Light cover foil.

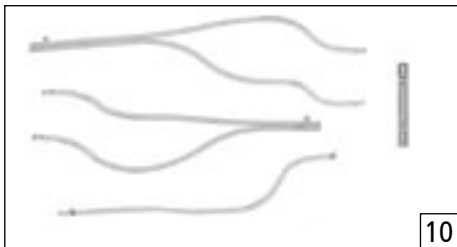

15

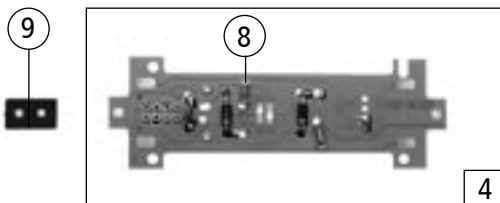

17 o. Abb. / no ill.
Anlaufscheibe
Washer disk

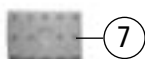
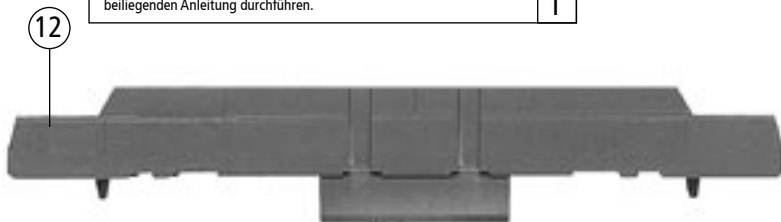
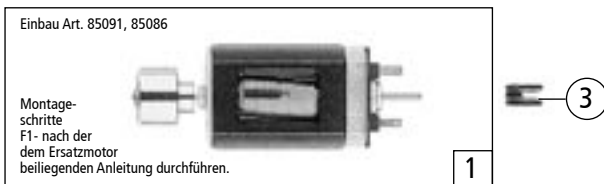

Pos. Nr. Pos.no. Position	Beschreibung Description Désignation	Art.-Nr. Art.no. Ref.	Preisgruppe Price bracket Catégorie de prix
1	Motor komplett Motor assembly	85091	57
2	Schraube 2,2 x 9,5 Screw 2,2 x 9,5	85799	2
3	Kardanschale kurz Cardan bearing short	87129	3
4	Platine komplett Printed circuit assembly	87867	43
5	Puffer gewölbt Buffer vaulted	88629	4
6	Puffer flach Buffer flat	88630	4
7	Gummibettung Rubber embedding	89728	3
8	Drahtlampe 16 V Light bulb 16 V	109321	10
9	Brückenstecker für DC Connector for DC	100644	7
10	Lichtleitstäbesatz Light transmission bar set	101236	9
11	Motorauflage Motor bearing	101238	3
12	Grundrahmen Frame	101243	30
13	Tank Tank	108592	15
14	Fenstersatz Window set	110148	10
15	Gehäuse komplett Betr. Nr. DR 132 201-5 Body assembly Betr. No. DR 132 201-5	115214	61
16	Teilesatz Parts set	115259	8
17	Anlaufscheibe 4x2,1x0,1 Washer disk 4x2.1x0.1	113942	2
18	Dachlüfter flach Roof exhauster flat	114459	2
19	E-Lokführer E train driver	110407	5
20	Lichtabdeckungsfolie Light cover foil.	115215	4

Änderungen in Konstruktion und Ausführung vorbehalten
We reserve the right to change the construction and specification
Nous nous réservons le droit de modifications techniques et
d'exécution ainsi que de la possibilité des livraisons

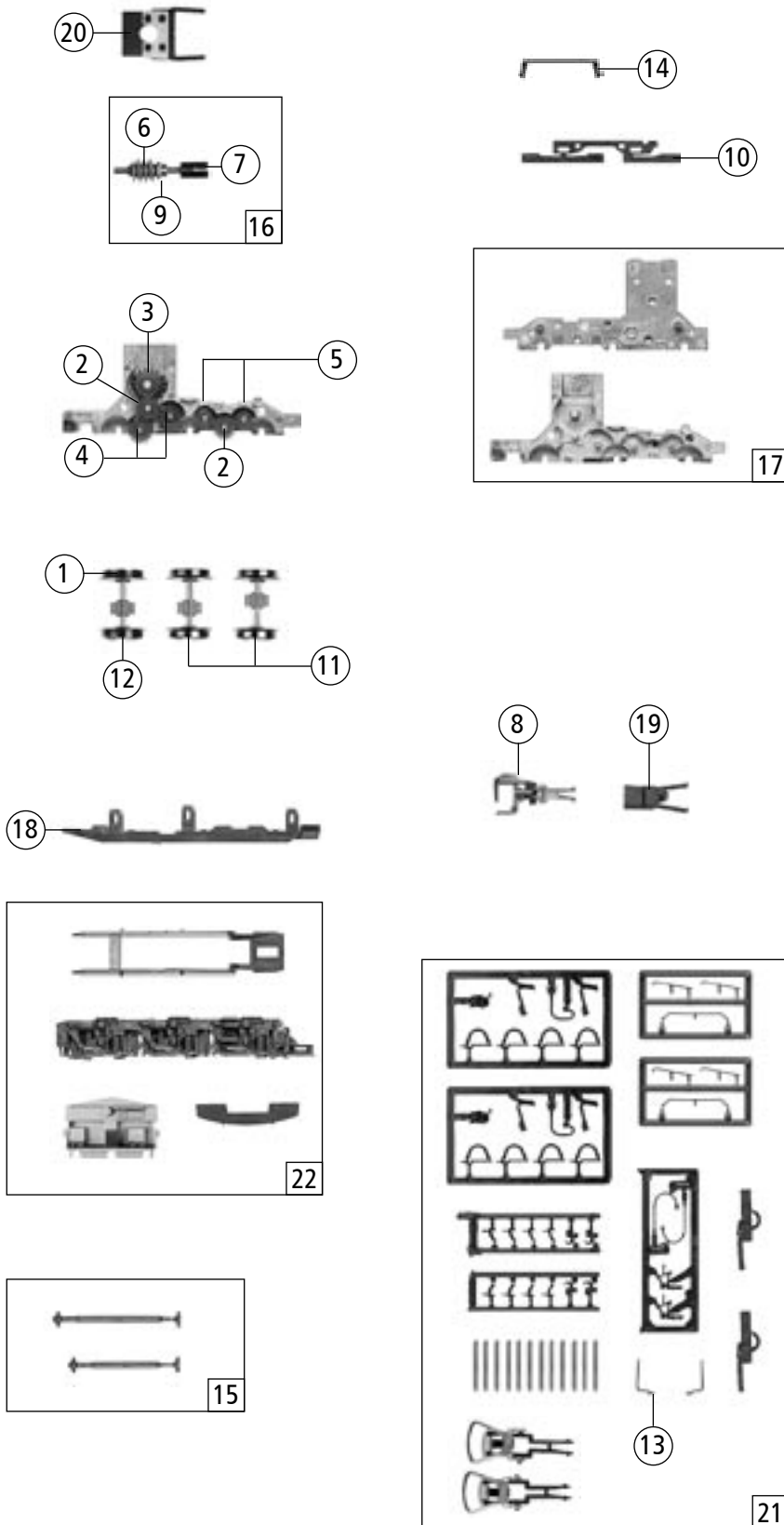

Pos. Nr. Pos. no. Position	Beschreibung Description Désignation	Art.-Nr. Art. no. Ref.	Preisgruppe Price bracket Catégorie de prix
1	Hafringesatz Set with traction tires	85622	19
2	Zahnrad z=17 / 0,4 G Gear T=17 / 0,4 G	86418	2
3	Schnecken Zahnrad für DC Gear for DC	86419	4
4	Zahnrad Z=18 Gear T=18	86460	2
5	Zwischenzahnrad Gear	86480	2
6	Schnecke (DC) Worm (DC)	86704	5
7	Kardanschale Cardan bearing	87152	2
8	Universalkupplung Universal coupling	89282	5
9	Lager für Schneckenachse Worm axle bearing	89749	6
10	Radkontakt Wheel current contact	89956	4
11	Radsatz ohne Hafring Wheel without traction tyre	90893	18
12	Radsatz mit 2 Hafringen Wheelset with 2 traction tires	90894	20
13	Leiter Step	101237	3
14	Kontakthalter Contact holder	101239	5
15	Teilesatz 2 Parts set 2	101240	11
16	Schneckensatz Worm set	101242	24
17	Getriebesatz Gear part set	101244	18
18	Deckel DC Cover DC	101245	5
19	Kupplungskammer Coupling holder	101452	2
20	Schneckendeckel mit Stabilisatorfeder Worm cover with vibration damper	108594	8
21	Zurüstbeutel Bag with accessories	108597	32
22	Teilesatz 1 Parts set 1	110149	24

Ersatzteile erhalten Sie bei Ihrem Fachhändler, oder Ihrer Landesvertretung oder bei:

You can order your Replacement Parts at your local dealer, your country representative or:

Passez commande des pièces détachées chez votre détaillant, chez le S.A.V. de votre importateur national ou en direct au S.V.A. ROCO:

Roco Modellspielwaren VertriebsgmbH & Co. Handels KG
Abt. Service
Georg-Wrede-Straße 49, D-83395 Freilassing
Telefon +49 (0) 86 54.476 30
Telefax +49 (0) 86 54.476 30
E-Mail: service@roco-online.de

Pos.Nr. Pos.no. Position	Beschreibung Description Désignation	Preisgruppe Price bracket Catégorie de prix	
		Art.-Nr. Art.no. Réf.	
1	Motor komplett <i>Motor assembly</i>	85091	57
2	Schraube 2,2 x 9,5 <i>Screw 2,2 x 9,5</i>	85799	2
3	Kardanschale kurz <i>Cardan bearing short</i>	87129	3
4	Platine komplett <i>Printed circuit assembly</i>	87867	43
5	Puffer flach <i>Buffer flat</i>	88630	4
6	Puffer gewölbt <i>Buffer vaulted</i>	88629	4
7	Gummibettung (o. Abb.) <i>Rubber embedding (no. ill.)</i>	89728	3
8	Drahtlampe 16 V <i>Light bulb 16 V</i>	109321	10
9	Brückenstecker für DC <i>Connector for DC</i>	100644	7
10	Lichtleitstäbesatz <i>Light transmission bar set</i>	101236	9
11	Motorauslage <i>Motor bearing</i>	101238	3
12	Grundrahmen <i>Frame</i>	101243	30
13	Tank <i>Tank</i>	108592	15
14	Fenstersatz <i>Window set</i>	110148	10
15	Gehäuse komplett Betr. Nr. 132 577-8 <i>Body assembly Betr. Nr. 132 577-8</i>	114458	61
16	Teilesatz <i>Parts set</i>	115259	8
17	Anlaufscheibe <i>Washer disk</i>	113942	2
18	Dachlüfter flach <i>Roof exhauster flat</i>	114459	2

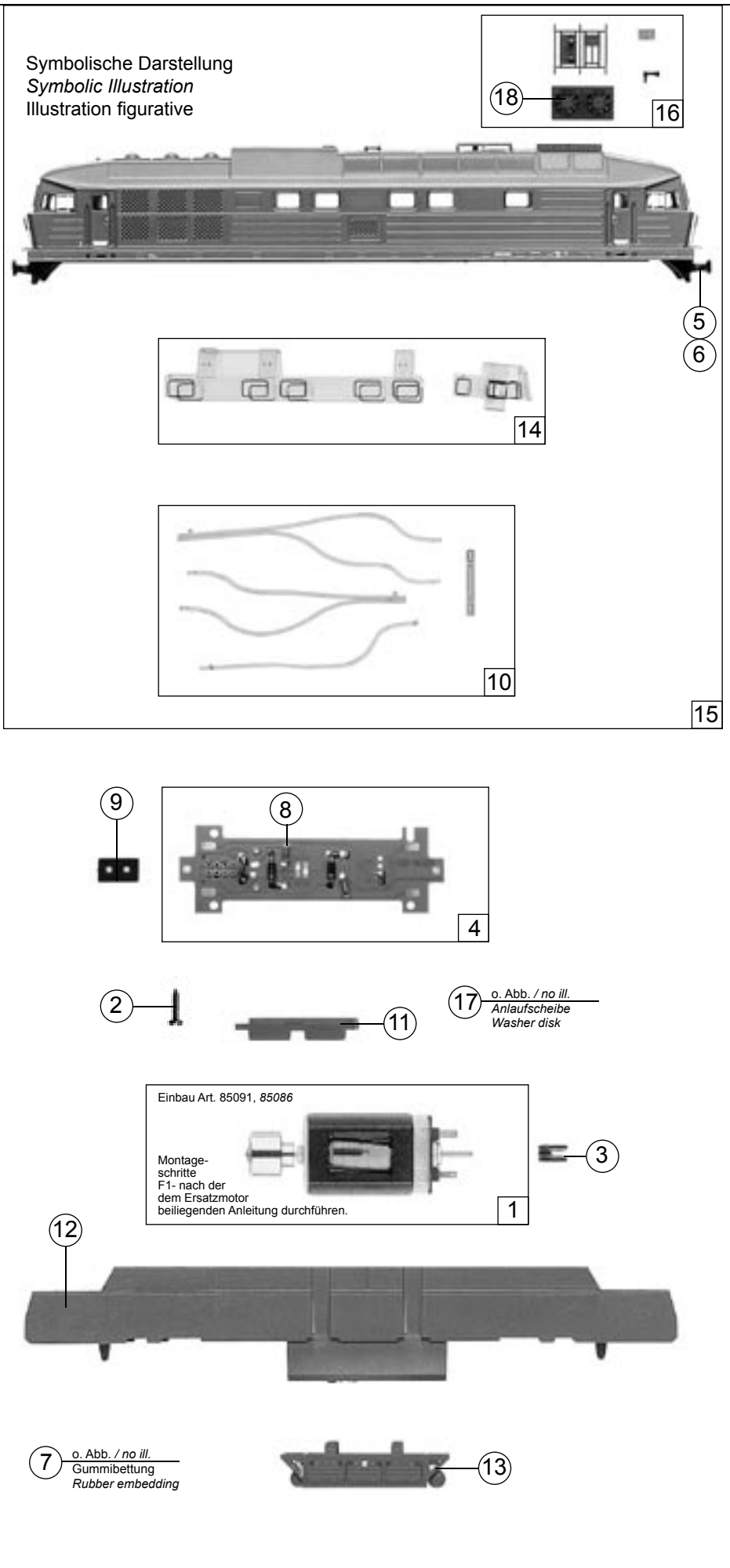

Pos.Nr. Pos.no. Position	Beschreibung Description Désignation	Preisgruppe Price bracket Catégorie de prix	
		Art.-Nr. Art.no. Réf.	
1	Hafringesatz <i>Set with traction tires</i>	85622	19
2	Zahnrad z=17 / 0,4 G <i>Gear T=17 / 0,4 G</i>	86418	2
3	Schnecken Zahnrad für DC <i>Gear for DC</i>	86419	4
4	Zahnrad Z=18 <i>Gear T=18</i>	86460	2
5	Zwischenzahnrad <i>Gear</i>	86480	2
6	Schnecke (DC) <i>Worm (DC)</i>	86704	5
7	Kardanschale <i>Cardan bearing</i>	87152	2
8	Universalkupplung <i>Universal coupling</i>	89282	5
9	Lager für Schneckenachse <i>Worm axle bearing</i>	89749	6
10	Radkontakt <i>Wheel current contact</i>	89956	4
11	Radsatz ohne Hafring <i>Wheel without traction tyre</i>	90893	18
12	Radsatz mit 2 Hafringen <i>Wheelset with 2 traction tires</i>	90894	20
13	Leiter <i>Step</i>	101237	3
14	Kontakthalter <i>Contact holder</i>	101239	5
15	Teilesatz 2 <i>Parts set 2</i>	101240	11
16	Schneckensatz <i>Worm set</i>	101242	24
17	Getriebebesatz <i>Gear part set</i>	101244	18
18	Deckel DC <i>Cover DC</i>	101245	5
19	Kupplungskammer <i>Coupling holder</i>	101452	2
20	Schneckendeckel mit Stabilisatorfeder <i>Worm cover with vibration damper</i>	108594	8
21	Zurüstbeutel <i>Bag with accessories</i>	108597	32
22	Teilesatz 1 <i>Parts set 1</i>	110149	24

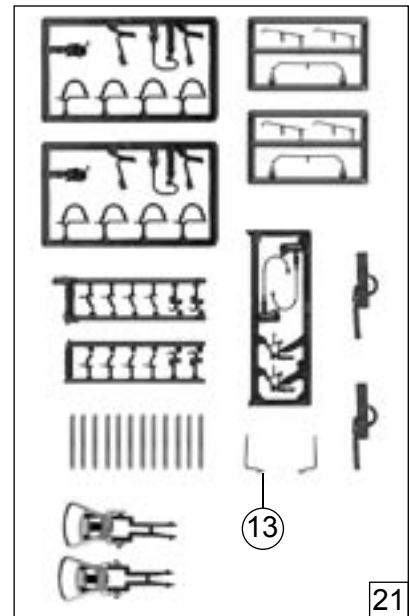
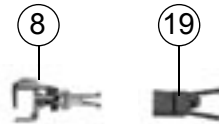
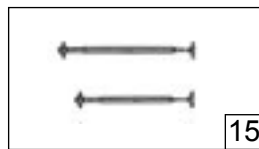
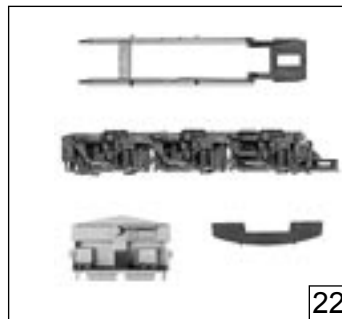
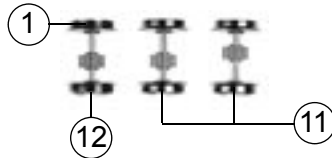
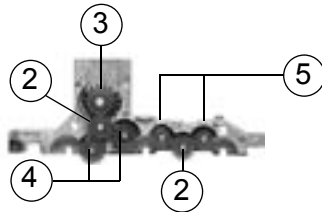
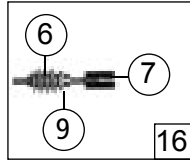
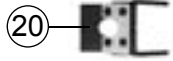

Ersatzteile erhalten Sie bei Ihrem Fachhändler, Ihrer Landesvertretung, oder bei:
You can order your Replacement Parts at your local dealer, your country representative, or:
Passez commande des pièces détachées chez votre détaillant, chez le S.A.V. de votre importateur national ou en direct au S.A.V. ROCO:

ROCO Modellsenspielwaren VertriebsgmbH & Co. Handels KG
— Service —
Georg-Wrede-Straße 49, D-83395 Freilassing
☎ +49 / (0)86 54 / 47 63 0
Fax: +49 / (0)86 54 / 47 63 50
E-Mail: service@roco-online.de

Pos.Nr. Pos.no. Position	Beschreibung Description Désignation	Preisgruppe Price bracket Catégorie de prix	Art.-Nr. Art.no. Réf.
1	Motor komplett <i>Motor assembly</i>	85091	57
2	Schraube 2,2 x 9,5 <i>Screw 2,2 x 9,5</i>	85799	2
3	Kardanschale kurz <i>Cardan bearing short</i>	87129	3
4	Platine komplett <i>Printed circuit assembly</i>	87867	43
5	Puffer flach <i>Buffer flat</i>	88502	4
6	Puffer gewölbt <i>Buffer vaulted</i>	88503	4
7	Gummibettung (o.Abb.) <i>Rubber embedding (no. ill.)</i>	89728	3
8	Drahtlampe 16 V <i>Light bulb 16 V</i>	109321	10
9	Brückenstecker für DC <i>Connector for DC</i>	100644	7
10	Lichtleitstäbesatz <i>Light transmission bar set</i>	101236	9
11	Motorauslage <i>Motor bearing</i>	101238	3
12	Grundrahmen <i>Frame</i>	101243	30
13	Tank <i>Tank</i>	108592	15
14	Fenstersatz <i>Window set</i>	110148	10
15	Gehäuse komplett <i>Body assembly</i>	113007	61

Symbolische Darstellung
Symbolic Illustration
Illustration figurative



5
6

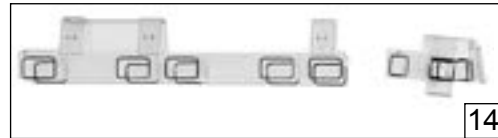

14

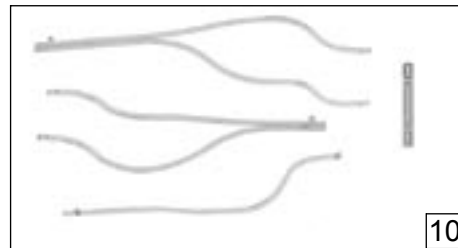

10

15

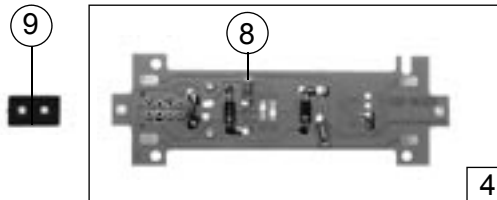

4



11

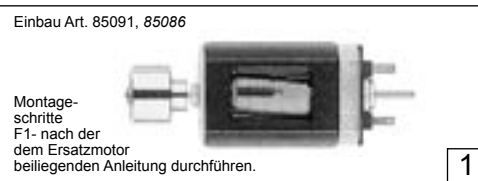

1

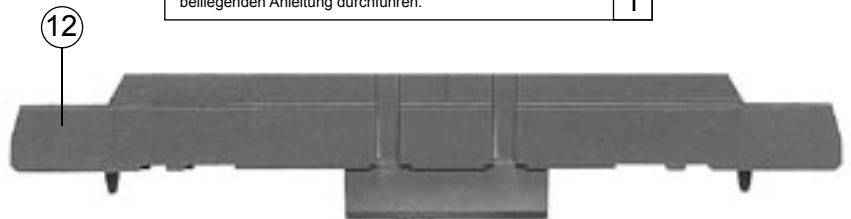

12

7 o. Abb. / no ill.
Gummibettung
Rubber embedding



13

Pos.Nr. Pos.no. Position	Beschreibung Description Désignation	Preisgruppe Price bracket Catégorie de prix	Art.-Nr. Art.no. Réf.
1	Hafringesatz Set with traction tires	85622	19
2	Zahnrad z=17 / 0,4 G Gear T=17 / 0,4 G	86418	2
3	Schnecken Zahnrad für DC Gear for DC	86419	4
4	Zahnrad Z=18 Gear T=18	86460	2
5	Zwischenzahnrad Gear	86480	2
6	Schnecke (DC) Worm (DC)	86704	5
7	Kardanschale Cardan bearing	87152	2
8	Universalkupplung Universal coupling	89282	5
9	Radkontakt Wheel current contact	89956	4
10	Radsatz ohne Hafring Wheel without traction tyre	90893	18
11	Radsatz mit 2 Hafringen Wheelset with 2 traction tires	90894	20
12	Leiter Step	101237	3
13	Kontakthalter Contact holder	101239	5
14	Teilesatz 2 Parts set 2	101240	11
15	Schneckensatz Worm set	101242	24
16	Getriebesatz Gear part set	101244	18
17	Deckel DC Cover DC	101245	5
18	Kupplungskammer Coupling holder	101452	2
19	Schneckendeckel mit Stabilisatorfeder Worm cover with vibration damper	108594	8
20	Zurüstbeutel Bag with accessories	108597	32
21	Teilesatz 1 Parts set 1	110149	24

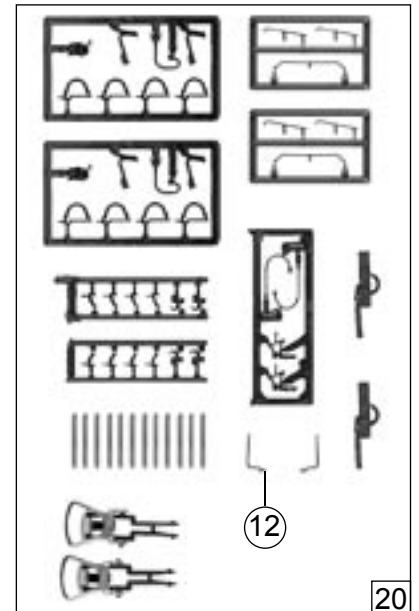
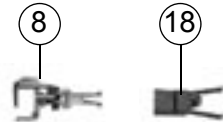
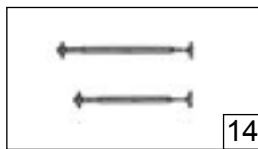
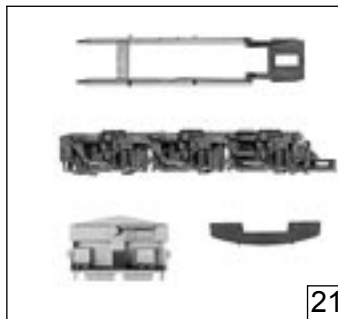
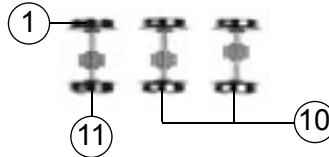
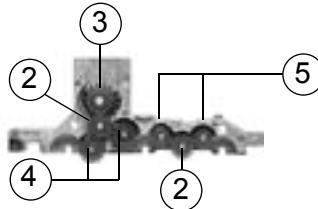
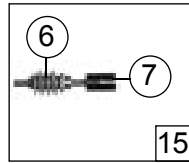

Ersatzteile erhalten Sie bei Ihrem Fachhändler, Ihrer Landesvertretung, oder bei:
You can order your Replacement Parts at your local dealer, your country representative, or:
 Passez commande des pièces détachées chez votre détaillant, chez le S.A.V. de votre importateur national ou en direct au S.A.V.
 ROCO:

ROCO Modellspielwaren VertriebsgmbH & Co. Handels KG - Service -
Georg-Wrede-Straße 49
D 83395 Freilassing
 ☎ +49 / (0)86 54 / 47 63 0
 Fax: +49 / (0)86 54 / 47 63 50
 E-Mail: service@roco-online.de

Pos.Nr. Pos.no. Position	Beschreibung Description Désignation	Preisgruppe Price bracket Catégorie de prix	
		Art.-Nr. Art.no. Réf.	
1	Motor komplett <i>Motor assembly</i>	85091	57
2	Schraube 2,2 x 9,5 <i>Screw 2,2 x 9,5</i>	85799	2
3	Kardanschale kurz <i>Cardan bearing short</i>	87129	3
4	Platine komplett <i>Printed circuit assembly</i>	87867	43
5	Puffer flach <i>Buffer flat</i>	88630	4
6	Puffer gewölbt <i>Buffer vaulted</i>	88629	4
7	Gummibettung (o. Abb.) <i>Rubber embedding (no. ill.)</i>	89728	3
8	Drahtlampe 16 V <i>Light bulb 16 V</i>	109321	10
9	Brückenstecker für DC <i>Connector for DC</i>	100644	7
10	Lichtleitstäbesatz <i>Light transmission bar set</i>	101236	9
11	Motorauslage <i>Motor bearing</i>	101238	3
12	Grundrahmen <i>Frame</i>	101243	30
13	Tank <i>Tank</i>	108592	15
14	Fenstersatz <i>Window set</i>	110148	10
15	Gehäuse komplett Betr. Nr. 132 577-8 <i>Body assembly Betr. Nr. 132 577-8</i>	114458	61
16	Teilesatz <i>Parts set</i>	112734	16
17	Anlaufscheibe <i>Washer disk</i>	113942	2
18	Dachlüfter flach <i>Roof exhauster flat</i>	114459	2

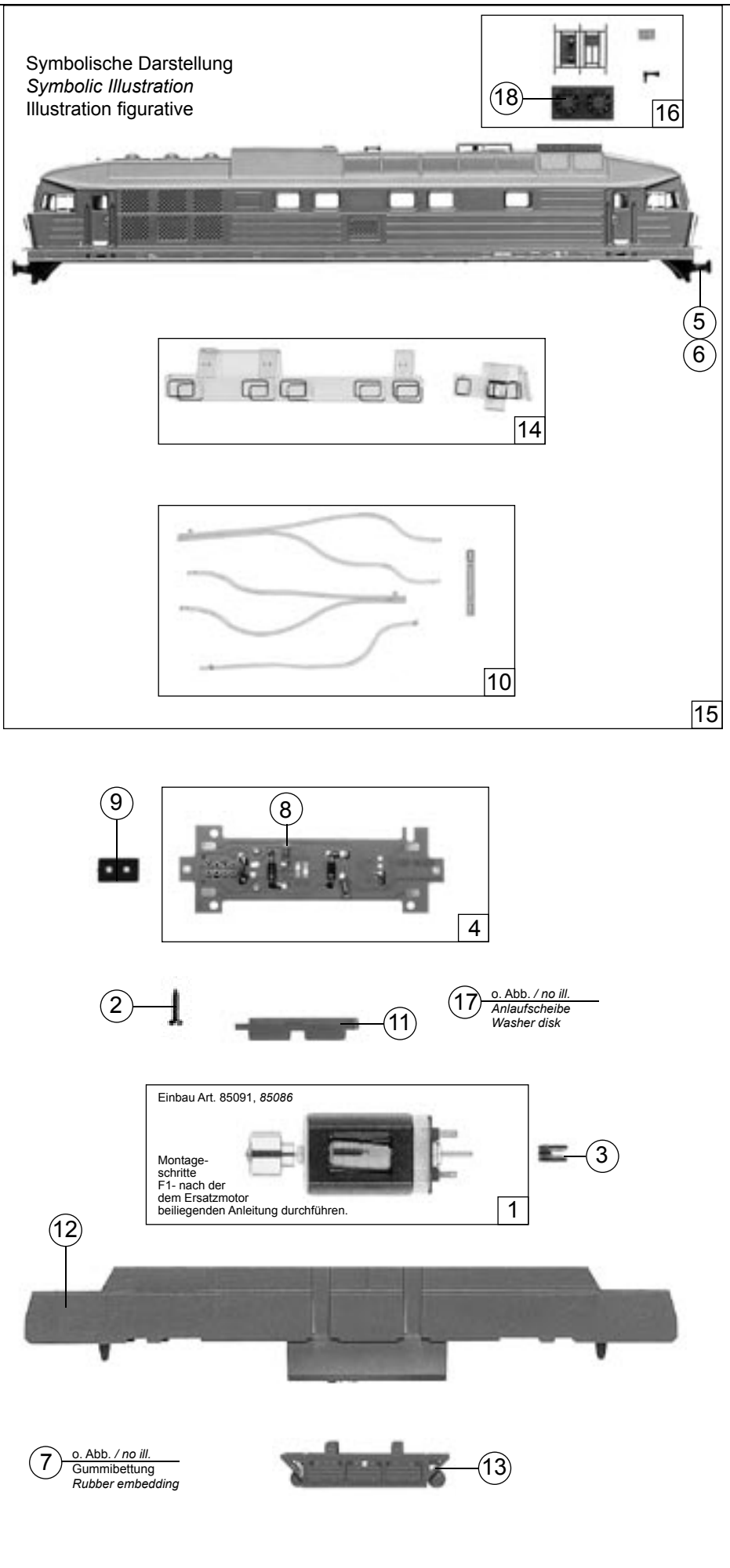

Pos.Nr. Pos.no. Position	Beschreibung Description Désignation	Preisgruppe Price bracket Catégorie de prix	
		Art.-Nr. Art.no. Réf.	
1	Hafringesatz <i>Set with traction tires</i>	85622	19
2	Zahnrad z=17 / 0,4 G <i>Gear T=17 / 0,4 G</i>	86418	2
3	Schnecken Zahnrad für DC <i>Gear for DC</i>	86419	4
4	Zahnrad Z=18 <i>Gear T=18</i>	86460	2
5	Zwischenzahnrad <i>Gear</i>	86480	2
6	Schnecke (DC) <i>Worm (DC)</i>	86704	5
7	Kardanschale <i>Cardan bearing</i>	87152	2
8	Universalkupplung <i>Universal coupling</i>	89282	5
9	Lager für Schneckenachse <i>Worm axle bearing</i>	89749	6
10	Radkontakt <i>Wheel current contact</i>	89956	4
11	Radsatz ohne Hafring <i>Wheel without traction tyre</i>	90893	18
12	Radsatz mit 2 Hafringen <i>Wheelset with 2 traction tires</i>	90894	20
13	Leiter <i>Step</i>	101237	3
14	Kontakthalter <i>Contact holder</i>	101239	5
15	Teilesatz 2 <i>Parts set 2</i>	101240	11
16	Schneckensatz <i>Worm set</i>	101242	24
17	Getriebebesatz <i>Gear part set</i>	101244	18
18	Deckel DC <i>Cover DC</i>	101245	5
19	Kupplungskammer <i>Coupling holder</i>	101452	2
20	Schneckendeckel mit Stabilisatorfeder <i>Worm cover with vibration damper</i>	108594	8
21	Zurüstbeutel <i>Bag with accessories</i>	108597	32
22	Teilesatz 1 <i>Parts set 1</i>	110149	24

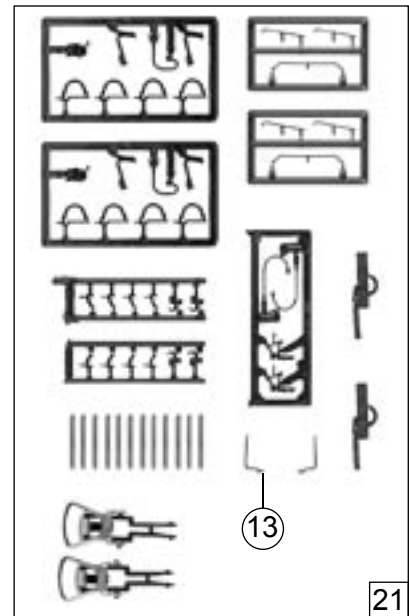
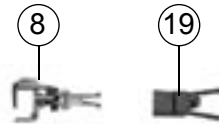
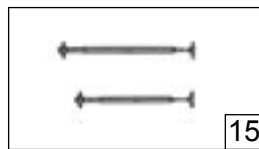
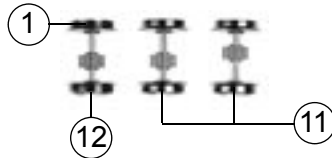
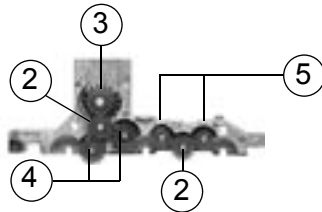
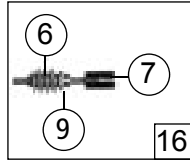
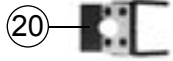

Ersatzteile erhalten Sie bei Ihrem Fachhändler, Ihrer Landesvertretung, oder bei:
You can order your Replacement Parts at your local dealer, your country representative, or:
Passez commande des pièces détachées chez votre détaillant, chez le S.A.V. de votre importateur national ou en direct au S.A.V. ROCO:

ROCO Modellsenspielwaren VertriebsgmbH & Co. Handels KG
— Service —
Georg-Wrede-Straße 49, D-83395 Freilassing
☎ +49 / (0)86 54 / 47 63 0
Fax: +49 / (0)86 54 / 47 63 50
E-Mail: service@roco-online.de