

16 o. Abb. / no ill.  
Sounddecoder Version 3.5  
Sounddecoder Version 3.5

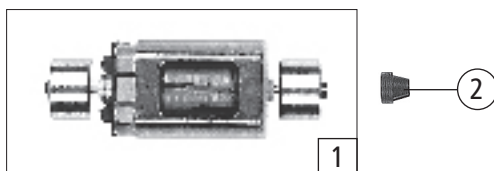
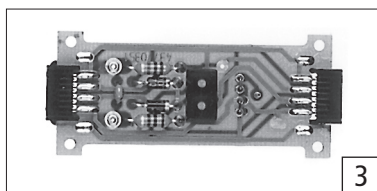

| Pos. Nr.<br>Pos. no.       | Beschreibung<br>Description   | Art.-Nr.<br>Art. no. | Preisgruppe<br>Price bracket |
|----------------------------|---|----------------------|------------------------------|
| 62712                      | DSB Mz  |                      |                              |
| 68712                      |   | ~                    |                              |
| 62713                      | DSB Mz  |                      | 🔊                            |
| 68713                      |   | ~                    | 🔊                            |
| 1                          | Motor<br>Motor  | 85111                | 28                           |
| 2                          | Kardanschale kurz<br>Cardan bearing short                           | 87129                | 4                            |
| 3                          | Motorplatine<br>Printed circuit for Motor                           | 87838                | 19                           |
| 4                          | Brückenstecker<br>Bridge connector                                  | 100644               | 6                            |
| 5                          | Drahtlampe T3/4 16V 30mA<br>Bulb T3/4 16V 30mA                      | 108616               | 8                            |
| 6                          | GF - Schraube M2x5<br>GF - Screw M2x5                               | 114966               | 3                            |
| 7                          | Lampen - Flexplatine<br>Flexible printed circuit for bulbs          | 200125               | 14                           |
| 8                          | Gehäuse komplett Betr. Nr. 1420<br>Casing assembly loco no. 1420    | 200126               | 31                           |
| 9                          | Zurüstbeutel Griffe schwarz<br>Bag with accessories grasp black     | 200129               | 10                           |
| 10                         | TS - Fenster - Beleuchtungssatz<br>Window - Lightings set           | 200134               | 12                           |
| 11                         | Teilesatz Gehäuse<br>Casing parts set                               | 200135               | 14                           |
| 12                         | Rechteckpuffer links<br>Buffer left                                 | 200136               | 3                            |
| 13                         | Rechteckpuffer rechts<br>Buffer right                               | 200137               | 3                            |
| 14                         | Griffstangensatz L=20,77/ L=12,75<br>Grasp bar set L=20,77/ L=12,75 | 200139               | 11                           |
| <b>Sound 62713 / 68713</b> |   |                      |                              |
| 15                         | Lautsprecher<br>Loudspeaker   | 113388               | 13                           |
| 16                         | Sounddecoder Version 3<br>Sounddecoder Version 3                    | 121800               | 39                           |

Änderungen in Konstruktion und Ausführung vorbehalten  
We reserve the right to change the construction and specification

|       |     |    |   |   |
|-------|-----|----|---|---|
| 62712 | DSB | Mz |   |   |
| 68712 |     |    | ~ |   |
| 62713 | DSB | Mz |   | 🔊 |
| 68713 |     |    | ~ | 🔊 |

| Pos. Nr.<br>Pos.no. | Beschreibung<br>Description  | Art.-Nr.<br>Art.no. | Preisgruppe<br>Price bracket |
|---------------------|--|---------------------|------------------------------|
| 1                   | Hafringsatz 10 Stk. 10,3-12,8<br>Set with traction tires 10 pieces 10,3-12,8 | 40069               | ---                          |
| 2                   | Zugfeder<br>Spring   | 86208               | 3                            |
| 3                   | Schneckenzahnrad doppelt<br>Worm gear double                                 | 86419               | 6                            |
| 4                   | Zahnrad Z=18 gerade M=04,4<br>Gear Z=18                                      | 86460               | 3                            |
| 5                   | Standardkupplung<br>Coupling standard  | 89246               | 6                            |
| 6                   | Zahnrad Z=14<br>Gear Z=14  | 111115              | 3                            |
| 7                   | Radsatz ohne Haftring<br>Wheelset without traction tyre                      | 112462              | 11                           |
| 8                   | Radsatz mit 2 Haftringen<br>Wheelset with 2 tractions tyre                   | 112463              | 12                           |
| 9                   | GF - Schraube 1,6x6<br>GF - Screw 1,6x6                                      | 114836              | 3                            |
| 10                  | GF - Schraube 1,6x8<br>GF - Screw 1,6x8                                      | 115026              | 3                            |
| 11                  | GF - Schraube 1,6x5<br>GF - Screw 1,6x5                                      | 115269              | 3                            |
| 12                  | Grundrahmen<br>Frame   | 117602              | 12                           |
| 13                  | Zahnrad Z=16 schwarz<br>Gear Z=16  | 117617              | 3                            |
| 14                  | Teilesatz Antrieb<br>Part set driver   | 200115              | 12                           |
| 15                  | Teilesatz Unterteil<br>Part set chassis                                      | 200124              | 14                           |
| 16                  | Zurüstbeutel<br>Bag with accessories   | 200127              | 12                           |
| 17                  | Teilesatz Getriebe<br>Part set gear  | 200130              | 12                           |
| 18                  | Radkontaktbaugruppe<br>Kcontact set wheel                                    | 200131              | 8                            |
| 19                  | Blendensatz<br>Bogie set   | 200132              | 14                           |
| 20                  | Blendensteckteilesatz<br>Parts set for bogie                                 | 200138              | 7                            |

| AC - Wechselstrom 68712/ 68713 |   |        |     |
|--------------------------------|---|--------|-----|
| 21                             | Decoder Motorola<br>Decoder Motorola  | 10738  | --- |
| 22                             | Hafringsatz 10 Stk. 10,3-12,4<br>Set with traction tires 10 pieces 10,3-12,4    | 40074  | --- |
| 23                             | Schleifer 46mm<br>Wiper 46mm  | 86031  | 14  |
| 24                             | Radsatz mit 2 Haftringen<br>Wheelset with 2 tractions tyre                      | 112322 | 12  |
| 25                             | Radsatz mit Zahnrad ohne Haftringen<br>Wheelset with gear without traction tyre | 112323 | 11  |
| 26                             | Radsatz ohne Zahnrad<br>Wheelset without gear                                   | 112685 | 10  |
| 27                             | Getriebeboden AC<br>Gear bottom AC  | 117607 | 3   |

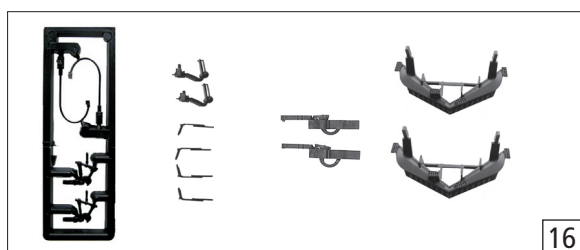
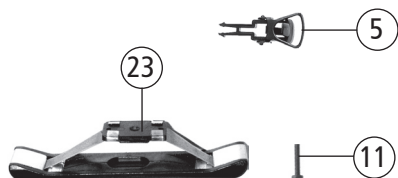
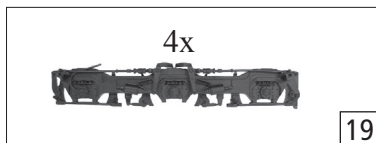
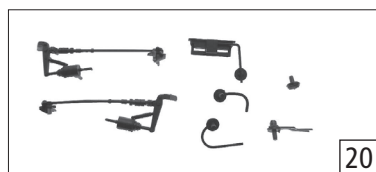
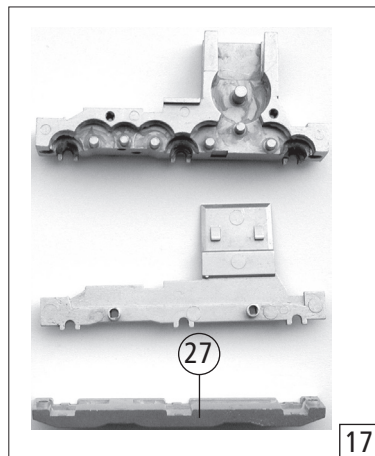
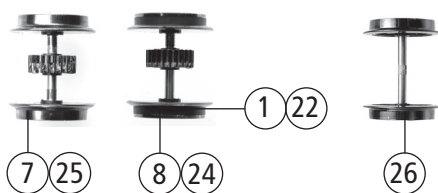
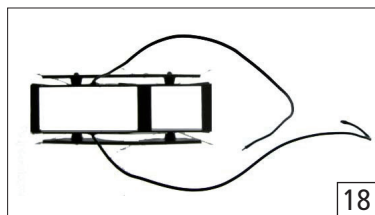
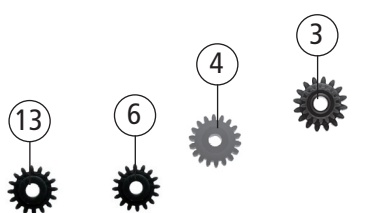
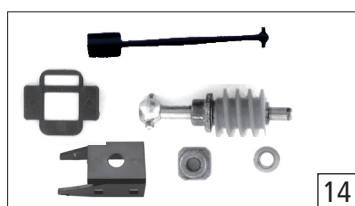
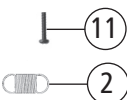
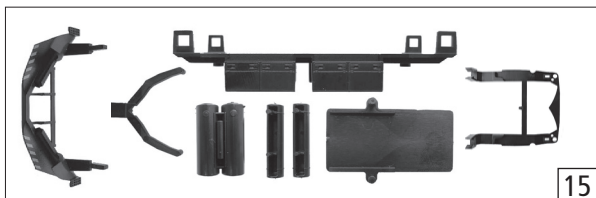
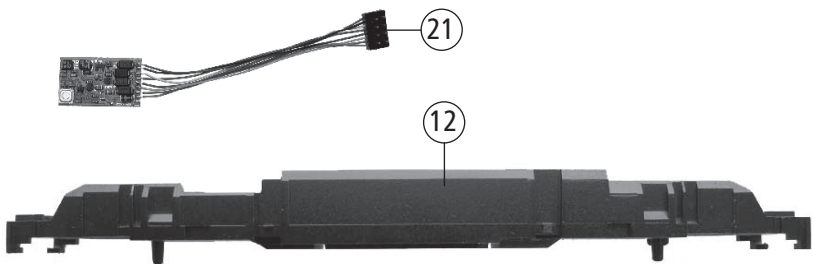

Ersatzteile erhalten Sie bei Ihrem Fachhändler,  
oder Ihrer Landesvertretung:

You can order your Replacement Parts at your local dealer, your country representative.